

Vehicle Technology Programs



Thomas J. Gross
Deputy Assistant Secretary
Office of Transportation Technologies
Office of Energy Efficiency and Renewable Energy

Solid State Energy Conversion Alliance Workshop
March 29, 2001



Presentation Outline

- **OTT Mission**
- **Vehicle Technology Programs**
 - **Light-Duty Vehicles**
 - **Heavy-Duty Vehicles**
- **Fuels R&D**
- **Fuel Cell Program**
- **SECA-Related R&D**



OTT Mission

...support the development and use of advanced transportation vehicles and fuels which will reduce energy demand, particularly for petroleum; reduce greenhouse gas emissions; and enable United States transportation to sustain a strong competitive position in domestic and world markets.



Partnerships Are Key to Success

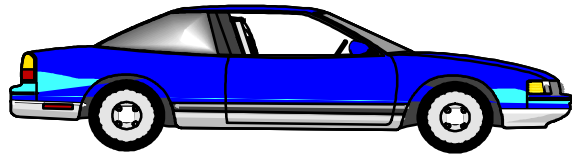

US AMP

Bioenergy Initiative



DRIVING FOR THE FUTURE



PARTNERSHIP FOR A NEW GENERATION OF VEHICLES

Government-Industry
21st Century Truck Partnership

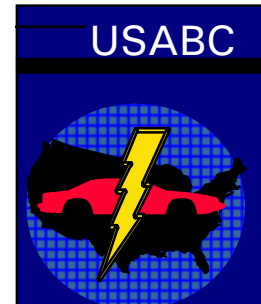
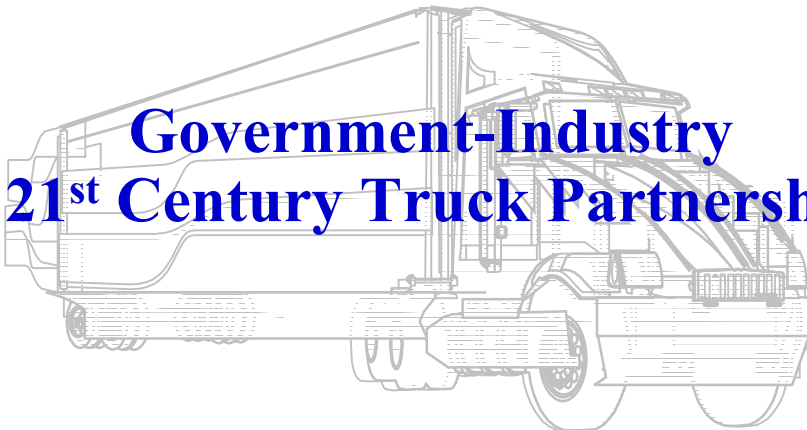



PNGV: An Historic Collaboration Between Industry & Government

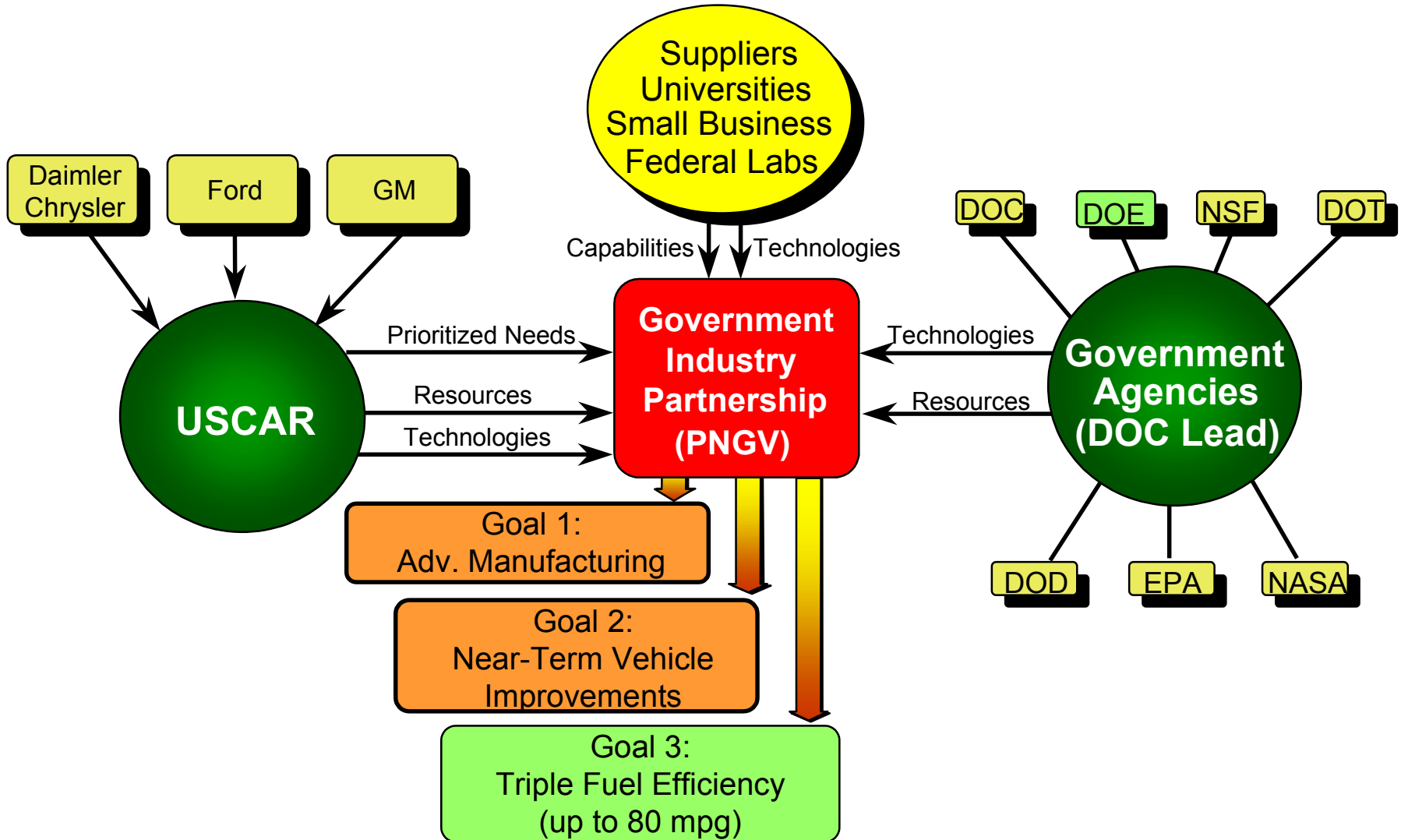



Technology Portfolio Continues to Evolve



Engine/Power Sources

- **Advanced Heat Engines**
 - DI Engines
 - HCCI
 - VCR
- **Combustion and Aftertreatment**
 - Lean NOX Catalyst
 - EGR
 - Traps
- **Fuel Cell**
- **Batteries**
 - NiMH Battery
 - Lithium Battery
- *Pneumatic/Hydraulic Storage*
- **Power Electronics**
 - Invertors/Controllers
 - Motors
 - Ultracapacitors – Electric

Systems Development

- **Aerodynamics**
- **Rolling Resistance – Tires**
- **Accessory Loads – HVAC**
- **Powertrain Configuration**
 - Parallel HEV
 - Series HEV

Fuels Utilization

- **Gasoline**
- **Diesel Fuels and Blends (<30 ppm sulfur)**
- **Natural Gas**
 - Methanol
 - Fischer-Tropsch
 - Dimethyl Ether
- **Ethanol**
- **Hydrogen**

Advanced Materials

- **Lightweight Materials**
 - Aluminum/Composite BIW
 - Composite BIW
- **Propulsion Materials**

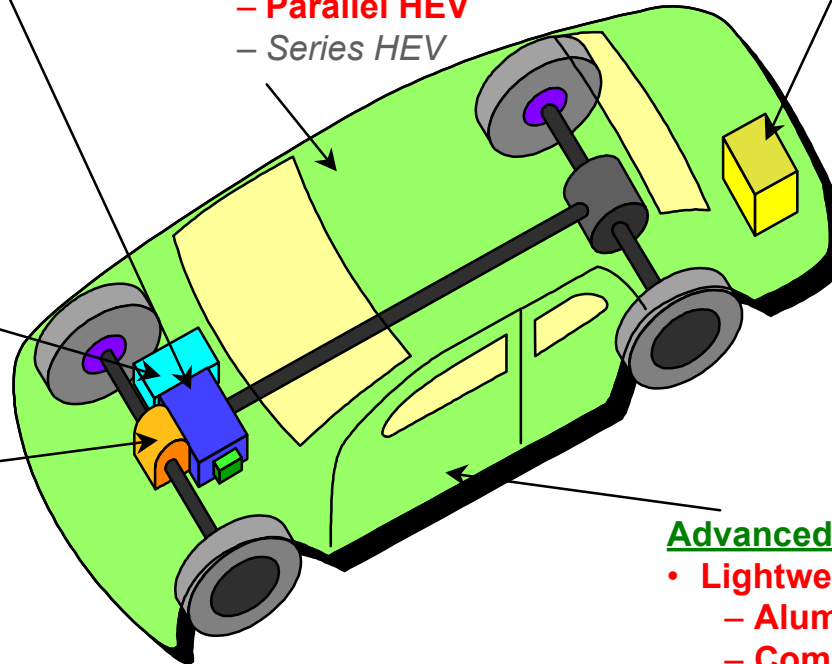

- Most promising options
- Other technologies



2000 PNGV Concept Vehicles



Ford Prodigy



- Lightweight materials reduce vehicle body structure weight 50%*
- Integrated starter/alternator*
- 33% reduction in aerodynamic drag
- Advanced diesel engine with 35% efficiency improvement projected to exceed 70 mpg (gasoline equivalent)*
- High-power battery *

DaimlerChrysler ESX3



- Body system weighs 46% less*
- Efficient diesel engine, motor, and battery projected at 72 mpg (gasoline equivalent)*
- Cost penalty halved to \$7500

GM Precept



- Vehicle body weight reduced 45% *
- World's most energy efficient vehicle lighting system
- Lowest drag coefficient ever recorded for a 5-p sedan
- Dual-axle parallel hybrid achieves 79.6 mpg (gasoline equivalent)

*Government supported technologies 7



The National Research Council Conducts Annual Reviews of PNGV

- ❑ Outstanding effort in meeting the concept car milestone in 2000
- ❑ Substantial technical progress noted in:
 - Vehicle engineering
 - Structural materials
 - 4-stroke, direct-injection engines
 - Fuel cells
 - Batteries
 - Power electronics
- ❑ Major barriers: costs, emissions, fuels
- ❑ Significant progress also observed for Goals 1 and 2



“Considering the magnitude of the challenges facing the program, PNGV is making good progress”

-- NRC Sixth Report of the PNGV



Technology Is Migrating into New U.S. Vehicles



- ❑ Hybrid-electric drives scheduled for:
 - Dodge Durango in 2003
 - Ford Escape in 2003
 - Chevrolet Silverado in 2004
 - and Ford Explorer in 2005
- ❑ 412 pounds of lightweight aluminum in the 2000 Lincoln LS
- ❑ Aluminum used for door, deck, and hood panels for Cadillac, Oldsmobile, and Chevrolet vehicles
- ❑ 50-pounds lighter composite pickup truck box on the 2001 Chevrolet Silverado
- ❑ Production of a new, lighter, recyclable thermoplastic hardtop for the Jeep Wrangler in 2001

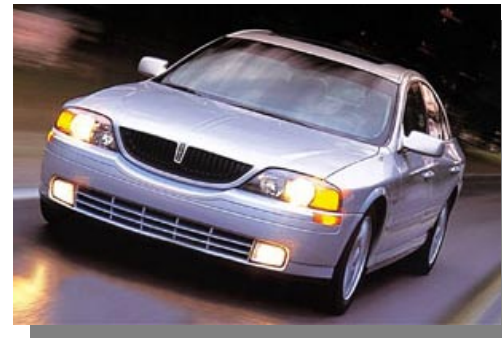



Difficult, but Surmountable, Research Challenges Remain to Achieve Very High Fuel Economy

- ❑ **Hybrid Systems:** Parallel configuration offers best option to meet 80 mpg. Series configuration may be used with fuel cells. Cost, weight, and packaging remain as challenges.
- ❑ **CIDI Engines:** Mature technology with 44% efficiency, but NOx and particulate emissions remain as challenges.
- ❑ **Fuel Cells:** Lowest onboard emissions and potential for highest efficiency, but cost, systems integration, and fueling infrastructure are major challenges.
- ❑ **Energy Storage:** Considerable progress in developing high-power battery; focus now on cost and cycle life.
- ❑ **Power Electronics:** Progress on cost, power-to-weight ratios, and efficiencies needed
- ❑ **Light Materials:** Significant weight reductions achieved. Major issues are cost, manufacturability, joining, recycling, and repair.
- ❑ **Fuels:** Fuel impacts on infrastructure must be addressed. Thorough evaluation is needed of the effects of fuel composition and physical properties on CIDI and fuel systems' performance.



21st Century Truck Partnership

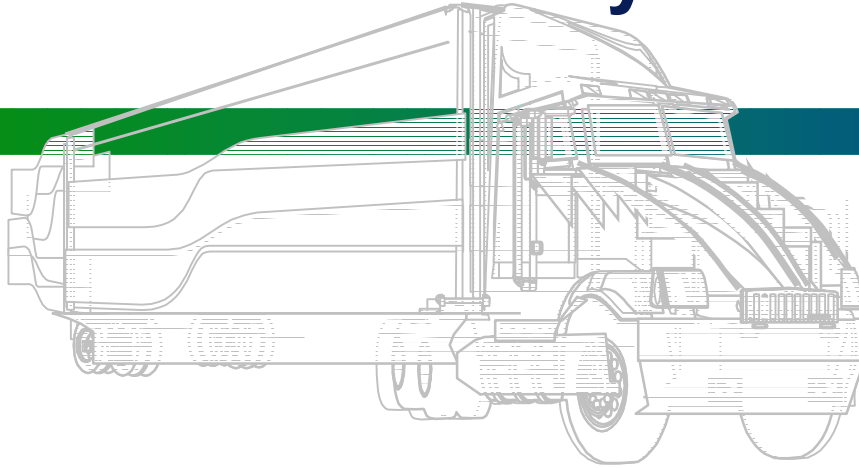

Department of Energy

DOE/EE/OTT
Heavy Vehicle
Technologies R&D



Department of Defense

Army/TACOM
NAC Military
Vehicle R&D



Department of Transportation

Intelligent Vehicle
and Highway
Safety R&D



Environmental Protection Agency

Vehicle
Emissions
Regulations

Industry Participants

Allison Transmission	General Motors
BAE SYSTEMS Controls	Honeywell
Caterpillar	International Truck and Engine
Cummins	Mack Trucks
DaimlerChrysler	NovaBUS
Detroit Diesel	Oshkosh Truck
Eaton Corporation	PACCAR
Freightliner	Volvo Trucks North America



21st Century Truck Partnership Declaration of Intent

Trucking industry's future depends on ability to produce affordable, high quality, safe, environmentally sensitive products.

- ❑ **Innovation needed** for U.S. truck manufacturers and suppliers to remain competitive worldwide;
- ❑ New truck and bus technologies will help truck owners and operators, and their customers, **cut fuel and operating costs and increase safety**;
- ❑ DOD would share gains and benefit from **reduced logistic costs** of transporting fuel during operations.



21st Century Truck Partnership Declaration of Intent

Develop production prototype vehicles that:

- ❑ **Improve fuel efficiency, specifically, by 2010;**
 - % double the Class 8 long-haul truck fuel efficiency*;
 - % triple the Class 2b and 6 truck (delivery van) fuel efficiency*; and
 - % triple the Class 8 transit bus fuel efficiency*;
- ❑ **Exceed expected emissions standards for 2010;**
- ❑ **Meet or exceed motor carrier safety goal of reducing truck fatalities by half in ten years; and**
- ❑ **Enhance affordability, and maintain or enhance performance.**

* on a ton-mile per gallon basis



Heavy Vehicles Technology Roadmap

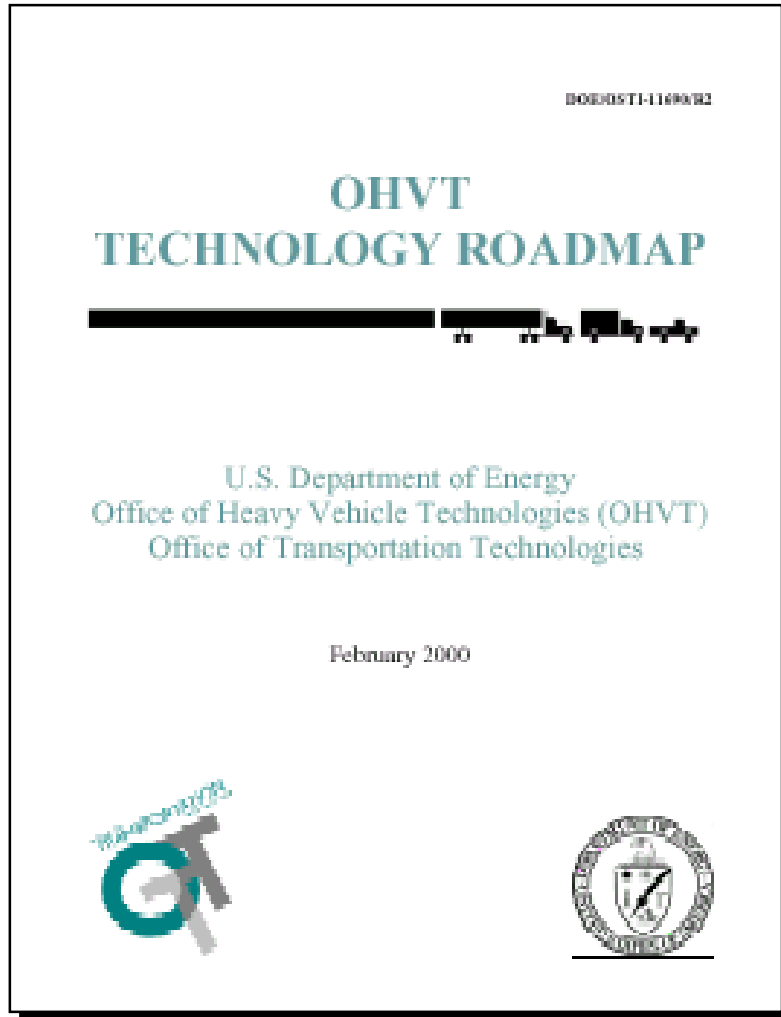

R&D needs of three groups of trucks are addressed

- Class 7 and 8, heavy-duty on-highway trucks
- Class 3-6, medium duty trucks such as urban delivery vans and transit buses.
- Class 1 and 2 light trucks (pickups, vans, and sport utility vehicles)

Independent review conducted by the National Research Council.



Heavy Vehicle Technologies R&D Goals

Heavy (Class 7-8) Trucks

To develop by 2004, the enabling technologies needed to achieve a fuel efficiency of at least **10 miles per gallon** (at 65 miles per hour) and **meet** emissions standards prevailing in 2004, using petroleum-based diesel fuel.

Medium (Class 3-6) Trucks

By 2004, to develop and demonstrate commercially viable vehicles that achieve, on an urban driving cycle, at least **double the fuel economy** of comparable current (1999) vehicles, and as a *research goal*, reduce criteria pollutant emissions to at **least 30 percent below** EPA standards prevailing in 2004.

Light (Class 1-2) Trucks

To develop by 2004 the enabling technologies for clean diesel engines to be competitive with and **at least 35-percent more fuel efficient** than equivalent gasoline engines for light trucks, while meeting Federal and state emissions standards prevailing in 2004.



OHVT/OAAT Advanced Petroleum-Based Fuels Program



**Multiyear Program Plan
Advanced Petroleum-Based Fuels (APBF) RD&T
for Compression-Ignition, Direct-Injection Engines
and Emission Control Systems**

**Office of Advanced Automotive Technologies
Office of Heavy Vehicle Technologies
Energy Efficiency and Renewable Energy**

November 1, 2000



Mission Undertake, with partners in the energy and transportation industries, research and development which will result in competitive, high performance, low emission fuel options for transportation vehicles.

Goals Identify, develop, and test new fuel formulations for automotive and truck engines that will be needed to simultaneously achieve high fuel economy and low emissions.



Alternative Fuels Program

A COMPREHENSIVE PROGRAM PLAN FOR NATURAL GAS VEHICLE RESEARCH

Prepared by
Office of Transportation Technologies
U.S. Department of Energy
May 1997

Goals

- Develop production-ready prototype vehicles – one Class 3-6 CNG and one Class 7/8 LNG – achieving 2007 emission standards and fully competitive with conventionally fueled counterparts.
- Develop enabling fueling infrastructure technology to promote use of CNG and LNG in medium- and heavy-duty engines.
- Attain capital cost of \$70 per DGE for LNG tank.
- Improve average thermal efficiency of NG engines to approach that of diesel engines.
- Understand atmospheric impacts of the use of petroleum-based and alternative transportation fuels.



Fuel Technology R&D Challenges

Alternative Fuels

❑ **Vehicle Integration**

- A clean-sheet design of Class 3-6 and Class 7-8 trucks will ensure full integration of CNG and LNG technologies in vehicles.

❑ **Engine Efficiency**

- Natural gas engines must overcome part-load and throttling efficiency losses to achieve diesel-like efficiencies.

❑ **Fueling Infrastructure**

- Advances are needed in cost-reduction, ease of handling, and safety to have full customer acceptance.

❑ **On-board Storage**

- Natural gas will have to be stored on-board at considerably lower pressures than current technology to address space and safety concerns.



Fuel Cells For Transportation Program Goal

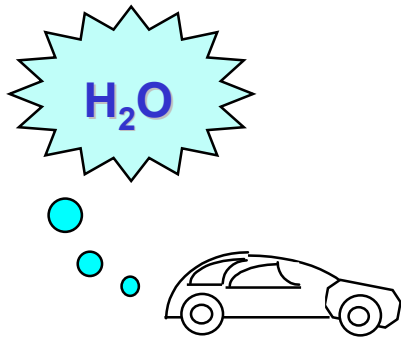

More MPG

Develop highly efficient,
low- or zero-emission,
cost-competitive

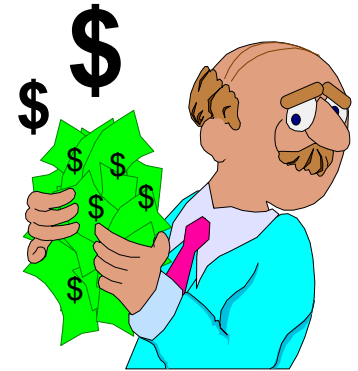

automotive fuel cell power system technologies
that operate on conventional & alternative fuels.

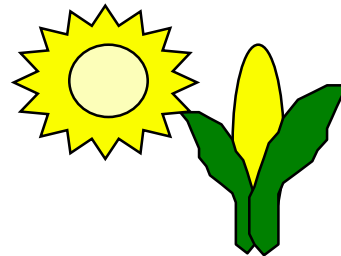
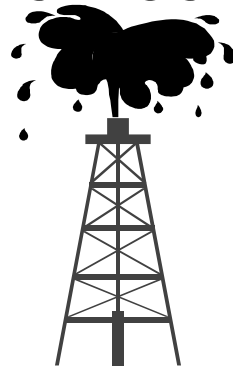



Fuel Strategy for Automotive Fuel Cells

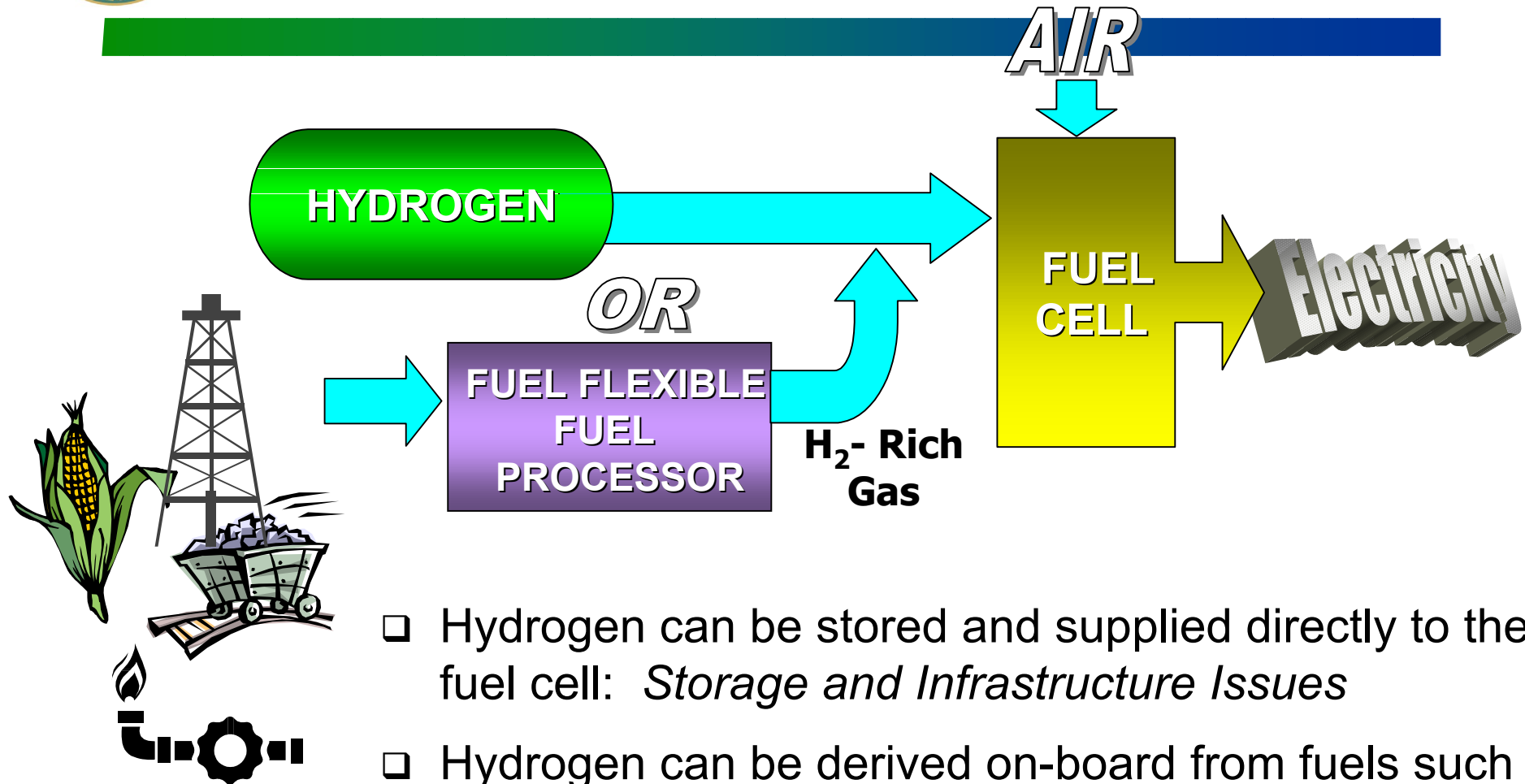

- ❑ Hydrogen can be stored and supplied directly to the fuel cell: *Storage and Infrastructure Issues*
- ❑ Hydrogen can be derived on-board from fuels such as ethanol, methanol, natural gas, gasoline or FT fuels: *Complexity, Cost, and Start-up Issues*



Program is Focused on Critical Technical Challenges

Significant technical and economic challenges will keep fuel cell vehicles from making significant market penetration for up to 10 years.

Major Challenges for Automotive PEM Fuel Cells:

- Cost**
- Efficiency (Higher Cell Voltage)**
- Air Management (Compressor Technology)**
- Startup (Fuel Processor Thermal Mass)**
- Thermal/Water Management**

Projects and Funding by Budget Category



Systems

- Plug Power/Nuvera
- International Fuel Cells
- Energy Partners, Honeywell
- A.D. Little (Cost Analysis)
- ANL (System Analysis)

FY01: \$7.6M

Fuel Processing

- Nuvera
- Hydrogen Burner
- McDermott
- Honeywell
- ADL/Acurex
- ANL, LANL, PNNL

FY01: \$21.5M

Stack Subsystem Components

- Energy Partners, AlliedSignal, IFC, Plug Power
- Gas Technology Institute
- 3M, SwRI/Gore, Foster-Miller
- Vairex, A.D. Little, AlliedSignal, Meruit
- LANL, LBNL, NRL, JPL

FY01: \$12.4M



Progress in Gasoline Fuel Cell Systems

Full Scale Gasoline Systems Are Being Demonstrated

1997:

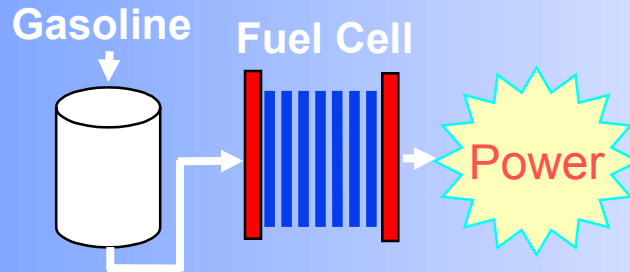

World's First Demonstration of PEM Fuel Cell Power from Gasoline - <1kW

1999:



Plug Power & Epyx (NUVERA) Demonstrate 10kW System on Multiple Fuels Including Gasoline, Methanol, and Ethanol

2000:

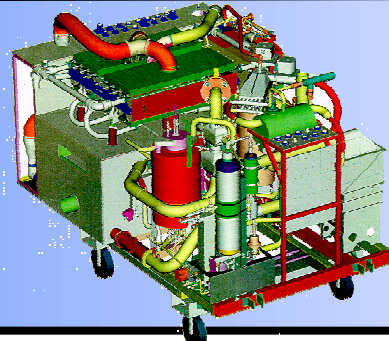

IFC Demonstrates 50 kW, Automated System on Gasoline



Significant Improvements in Fuel Cell System Size and Weight Have Been Made in the PNGV/DOE Program

50kW Gasoline Fuel Cell Power System*

- includes stack system, fuel processor, BOP
- gasoline systems and data unavailable in 1997-98

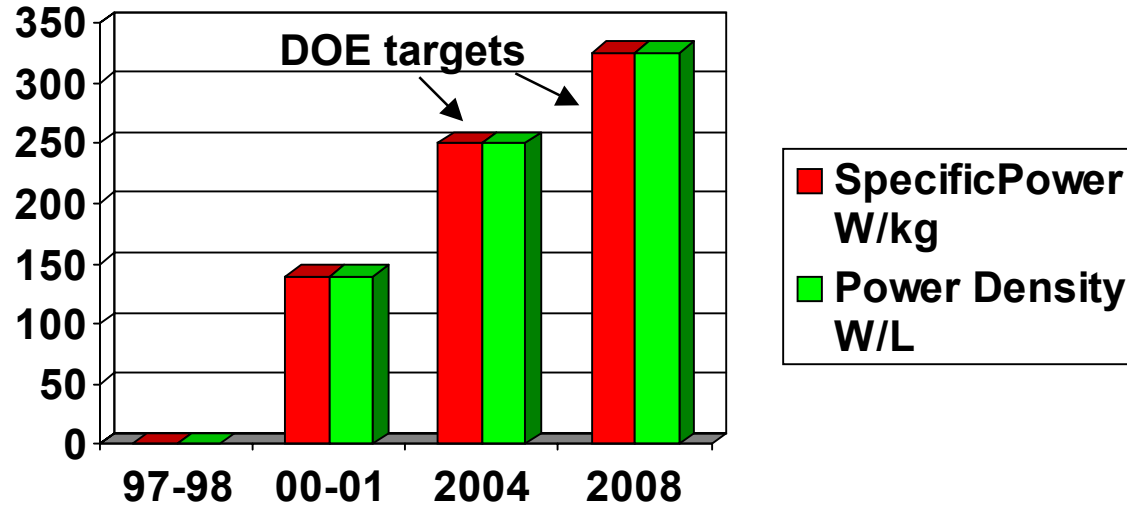

50kW Direct Hydrogen Fuel Cell Power System**

- includes stack, air/water management
- targets are for stack subsystem, i.e. excludes fuel processor, hydrogen storage

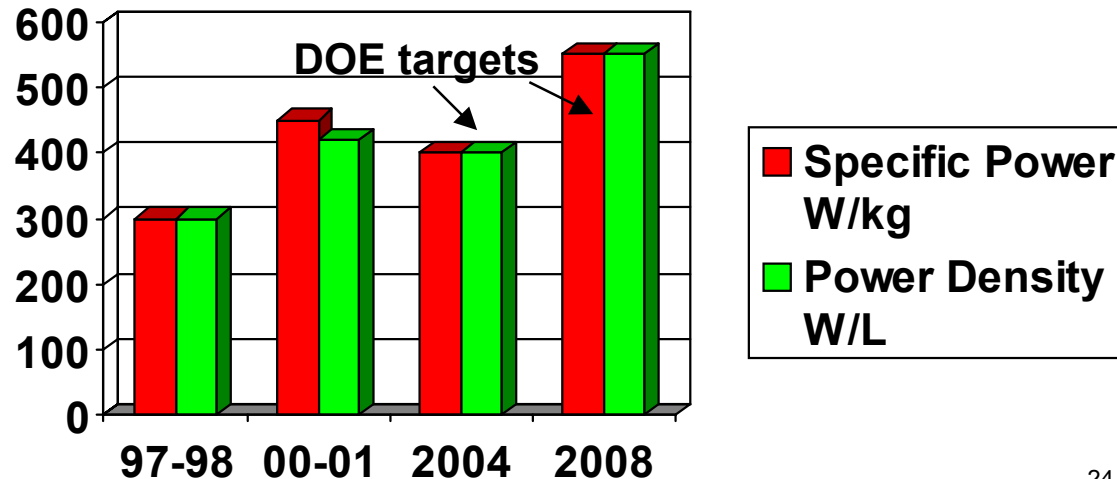

*Based on Plug Power

** Based on IFC



DOE is a Member of the CALIFORNIA FUEL CELL PARTNERSHIP



Goals

- Demonstrate vehicle technology
- Demonstrate the viability of alternative fuel infrastructure technology
- Explore the path to commercialization
- Increase public awareness

Members

- State of California (CARB/CEC/SCAQMD)
- Auto Manufacturers (DaimlerChrysler/Ford/Honda/Hyundai/Nissan/Volkswagen/General Motors/Toyota)
- Energy Providers (BP/Shell Hydrogen/Texaco/ExxonMobil)
- Fuel Cell Companies (Ballard/IFC/XCELLSiS)
- Associates (Air Products/Methanex/Praxair/Hydrogen Burner/Pacific G&E
Proton Energy/Stuart Energy/AC Transit/SunLine)
- Federal agencies (DOE/DOT)





SECA-Related R&D



OTT is developing fuel cells for auxiliary power units (APUs) in diesel trucks, and addressing the related technical challenges:

- **Diesel Reforming**

- eliminate carbon formation
- remove sulfur and/or develop sulfur tolerant catalysts

- **Solid Oxide Fuel Cells**

- develop rugged, low cost cell materials
- reduce startup time

Current R&D efforts are being carried by LANL, NETL, and ANL under the Transportation Fuel Cell Program.

Small businesses and universities will carry out R&D through the Cooperative Automotive Research for Advanced Technology (CARAT) Program.

Analyses of APUs for light and heavy vehicle applications will be conducted.



Summary

- ❑ **DOE's Office of Transportation Technologies is addressing the key technical challenges in the development of fuel-efficient vehicles for both light duty and heavy duty applications.**
- ❑ **Government-Industry partnerships are critical to the success of OTT's Vehicle Technology Programs.**
- ❑ **OTT's Fuel Cell Program has made tremendous progress; however, major technical challenges remain which prevent the introduction of fuel cell vehicles today.**
- ❑ **The Fuel Cell Program is developing fuel cell and fuel processing technologies in support of SECA.**

For more information, visit the OTT Web Site:
www.ott.doe.gov



Back-Up Slides



EE Stationary Fuel Cell Program

Program Goal

Develop and demonstrate a 50-kW PEM fuel cell for a commercial building by 2005

- operating on natural gas
- operating at high-temperature (120-140C)

R&D Focus

- High-temperature membranes
- Natural gas reforming
- System design